

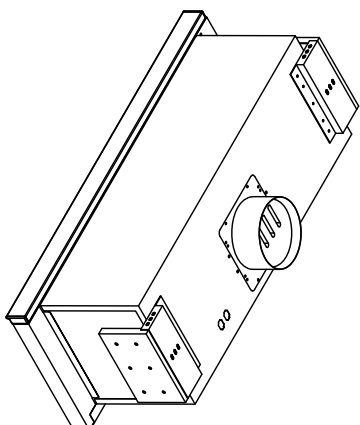

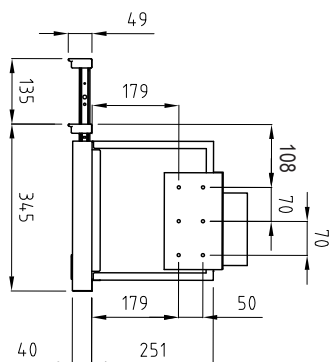

製品寸法図

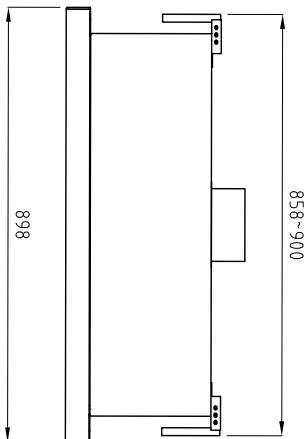
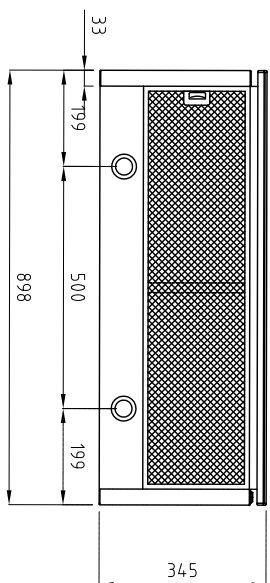
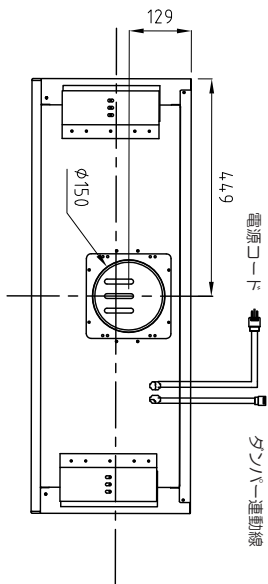

仕様

- 
押しボタン
- 
シルバー/ホワイト
- 
ハロゲンランプ
- 
ファルミ

特性表

定格電圧 (V)	定格周波数 (Hz)	スイッチ	定格消費電力 (W)	風量 (m ³ /h)		騒音 (dB)	重量 (kg)
				OPa	100Pa		
100	60	強	100	520	320	51	15
		弱	63	250	140	32	
		強	86	540	190	52	
	50	弱	54	270	70	33	
		強	86	540	190	52	
		弱	54	270	70	33	

風量曲線

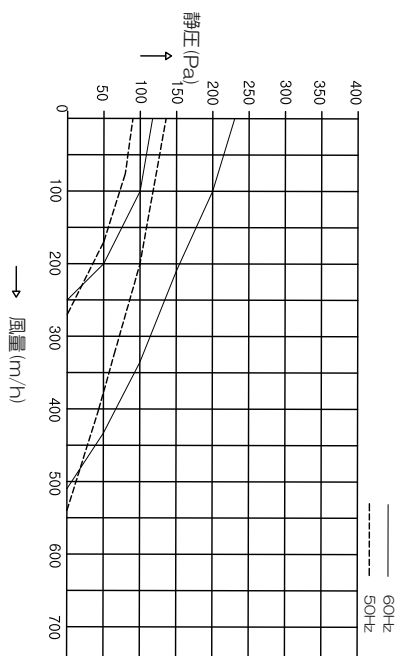

NO.	ECO-NO.	REVISION NOTE	DATE	DRAWN	CHECKED	APPROVED
MODEL NAME	HT-90 S/W	DWG. NAME	製品図			
CHECKED1		CHECKED2				

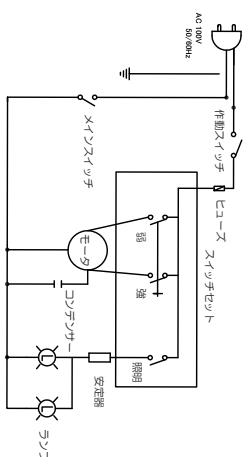

Double

DATE SHEET SIZE A4-H

UNIT mm SCALE 1/10